

SPECIFICATION SHEET - fittings

BRAND:	hansgrohe	Product Photo: 
ORIGIN:	Germany	
SERIES:	Metris C	
PRODUCT DESCRIPTION:	Trim set for 4-hole bath/shower mixer with extractable handshower • flow rate: 5 gal/min	
MODEL No.	31314 821	
FINISH/COLOUR:	Polished Nickel	
DIMENSIONS:		
OPTIONAL MATCHING PARTS:	06646000 concealed part	

Technical Informations: Suitable for continous flow water heater

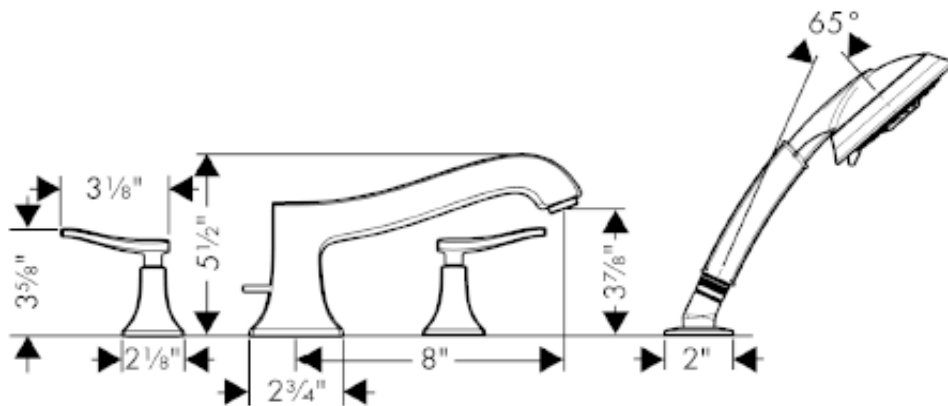

REMINDER: Pipe flushing must be done before faucets are installed. Failure to do so voids the warranty.
 Do not use cleaners containing abrasive cleansers, ammonia, bleach, acids, waxes, alcohol, solvents or other products not recommended for chrome.
 All information is for reference only, installation shall always be based on the actual product delivered.